



# Linear Motion Solutions for Food Processing Equipment

Advancing high-productivity applications with expertise and technology

[www.thomsonlinear.com](http://www.thomsonlinear.com)

** THOMSON<sup>®</sup>**  
A REGAL REXNORD BRAND



# Application. Design. Performance.

Thomson optimizes every step in the creation of dependable and durable food processing equipment.

Thomson has decades of experience in supplying technologically superior components that allow application flexibility while pushing production efficiency. We also streamline the sourcing process for components that can be trusted for longevity, washability, corrosion-resistance and performance.

Today we optimize motion for the food-processing industry through:

**Superior products.** We have the broadest selection and readily provide standard, modified standard and full custom solutions. Thomson supplies and optimizes:

- Rodded and rodless actuators
- Linear bearings
- Ball and lead screws
- Linear guides (round and square rail)
- Micron® planetary gearheads
- Linear slides and systems
- Deltran clutches, spring-set brakes and resolvers

**Superior technology.** Our products perform as promised and over-deliver on quality and longevity. Thomson components can:

- Withstand caustic cleaning and demanding use without corrosion through use of 300-grade (303, 304, 316) stainless, UHMW coatings, Armalloy and many more options
- Provide 120 psi (8.3 bar) spray-rated washdown compliance
- Offer food-grade Lube-for-Life lubrication

**Unbiased design solutions.** Our unmatched product line breadth encourages designs that don't compromise. Our commitment to fully agnostic solutions ensures this. We have the capability to test your application load and movement profiles to develop optimal solutions. Plus, we bring 70 years of experience in product solutions. We also specialize in:

- Zero-setup products for speed-to-market and optimal installed cost
- Electric actuator conversion from hydraulic or pneumatic
- Easy-to-use online sizing and selection tools at [www.thomsonlinear.com](http://www.thomsonlinear.com)

**Call on Thomson as a partner early in the design process to help you find the optimized motion solution for your application.**



## Integrate Our Expertise Into Your Design Process

When experienced Thomson engineers contribute early in your design process, you optimize machine performance, life and cost. Leverage our capacity for analysis, modifications and white sheet solutions. Take advantage of smart standardization that gives you more flexibility and improved speed to market. Rest easy knowing that the results will be predictably excellent. Here are some of the keys:

**WE DEVELOP** standard platforms that make any design easily customizable.

**WE PRODUCE** zero set-up products to get our clients to market faster and more cost-effectively.

**WE TEST** extensively on your equipment to enable evaluation of our products in your application.

Couple these process advancements with our highly proven, highly engineered components and pre-assembled systems, and you've optimized your food processing machine project.

## We Participate in a Wide Range of Food Processing Applications

Through world-class components and systems, decades of motion-control expertise and a global footprint that includes more than 2000 distributors, we contribute to a very wide array of food processing applications:

Accumulators  
Bag fillers  
Blenders  
Capsule fillers  
Choppers  
Conveyors  
Cookers  
Cup fillers

Cutters  
Deboners  
Dumpers  
Elevators  
Extruders  
Fillers  
Form, fill and seal  
Heat exchanges

Injectors  
Loaders  
Material handling/palletizers  
Meat processing  
Mixers  
Ovens  
Patty formers  
Pick and place

Pouch machines  
Presses/cutters  
Scales  
Separators  
Slicers

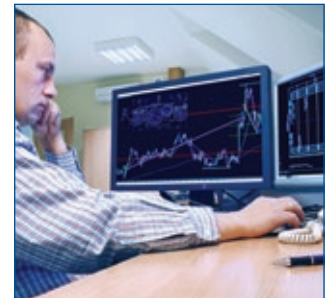

Leverage our capacity for analysis, modifications and white paper solutions.



Trust our testing of your equipment to optimize your product application decisions.

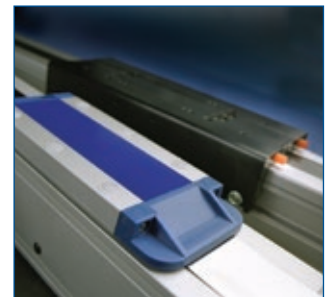

Reach market faster with our zero-set-up products.

## Bread robot

Two-axis packaging robots do considerable work in assembling and packing food items like baked goods, boxed cereal, boxed dairy products and mincemeat in trays. The system involves picking, placing, arranging and conveying individual items and the final packages. A wide range of Thomson components contribute to this vital food processing function, including ball screws, guides, full linear motion systems, and planetary gears and servo motors – all meeting strict washdown demands.

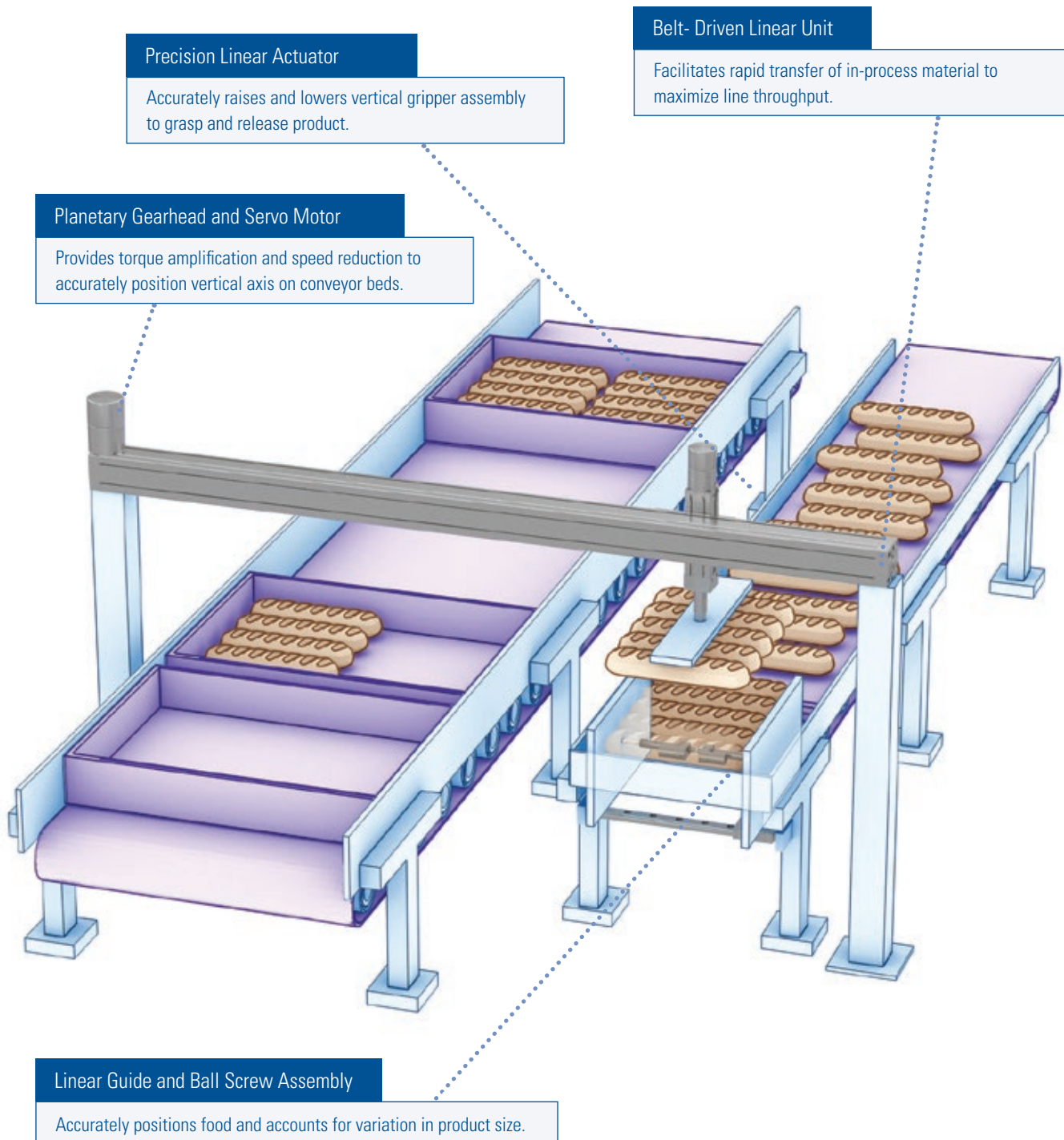



## Skewer/Assembly

Thomson's components and solutions shine in high-throughput, multi-axis applications such as assembly lines with skewers. Skewer units employ gearheads and clutches, brakes and resolvers, and rodless actuators in optimal combinations. Skewer units can employ dual guides for raising and lowering, or these can be replaced with a single profile rail or two profile rails. These also employ clutches and gearboxes to complement the motor unit.

These multi-axis food-processing applications are tailor-made for Thomson's integrated solutions. Consult with us early in the design process to leverage our testing capacity, customized solutions, sourcing advantages and ability to collaborate with partner divisions. The result will be a better machine that is delivered more quickly.

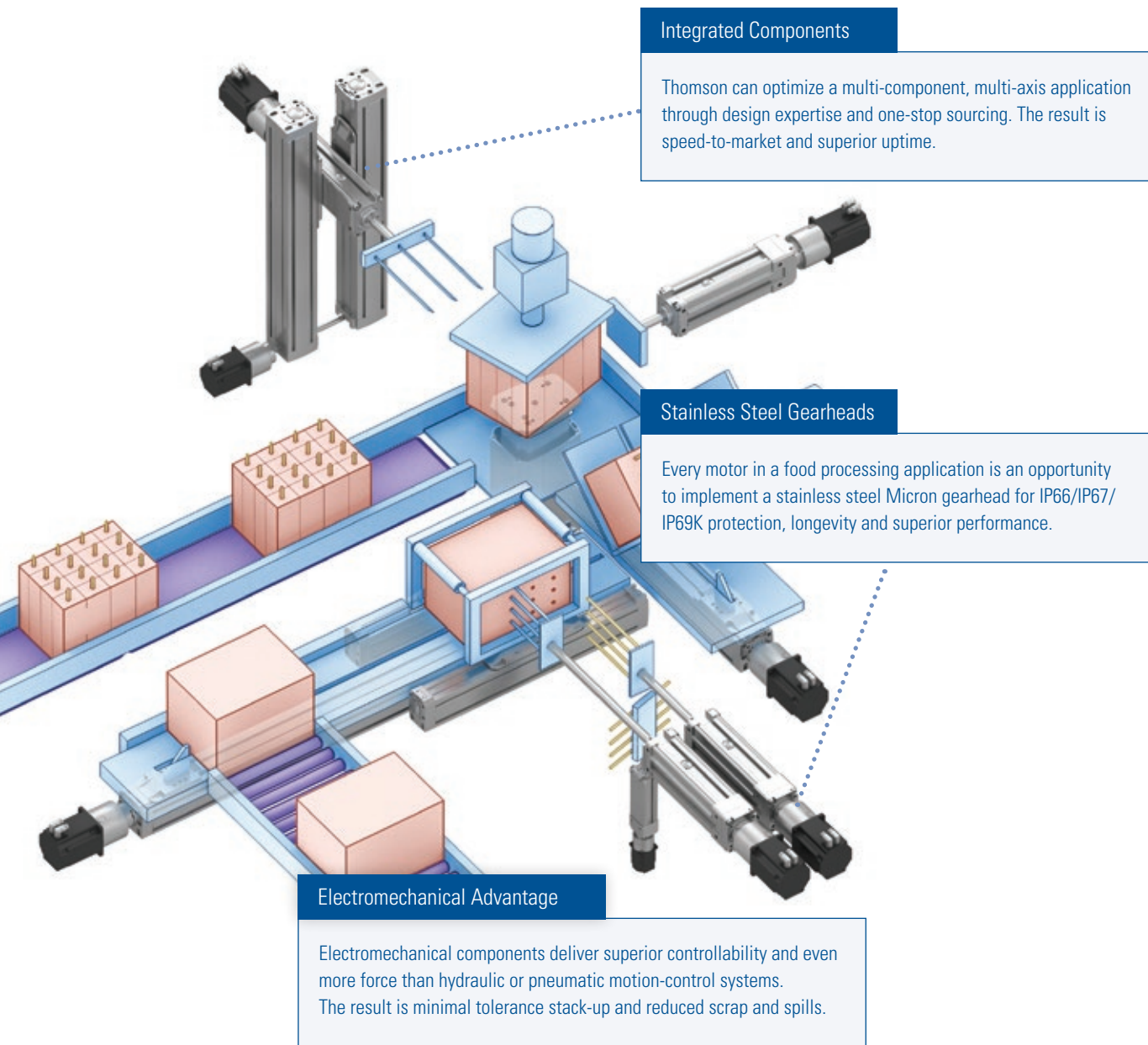

### Integrated Components

Thomson can optimize a multi-component, multi-axis application through design expertise and one-stop sourcing. The result is speed-to-market and superior uptime.

### Stainless Steel Gearheads

Every motor in a food processing application is an opportunity to implement a stainless steel Micron gearhead for IP66/IP67/IP69K protection, longevity and superior performance.

### Electromechanical Advantage

Electromechanical components deliver superior controllability and even more force than hydraulic or pneumatic motion-control systems. The result is minimal tolerance stack-up and reduced scrap and spills.

## Food Vending Machine

Actuators of multiple sizes, ball screws, gearheads and full linear motion systems combine to control the multiple stages in this application, where frozen dinner boxes are placed in a microwave and heated before being delivered to a hatch for the customer. Here, as with a food packaging robot, ball screws can replace actuators in many cases to provide more customizability at reasonable cost.

### Linear Actuator and Linear Motion System

The dinner box is pushed out of the freezer by a linear actuator and positioned sideways via a linear motion system, which is driven by a motor and a gearhead.

### Actuators

Actuators push the dinner box onto a transport conveyor and also open the hatch for access by the customer.

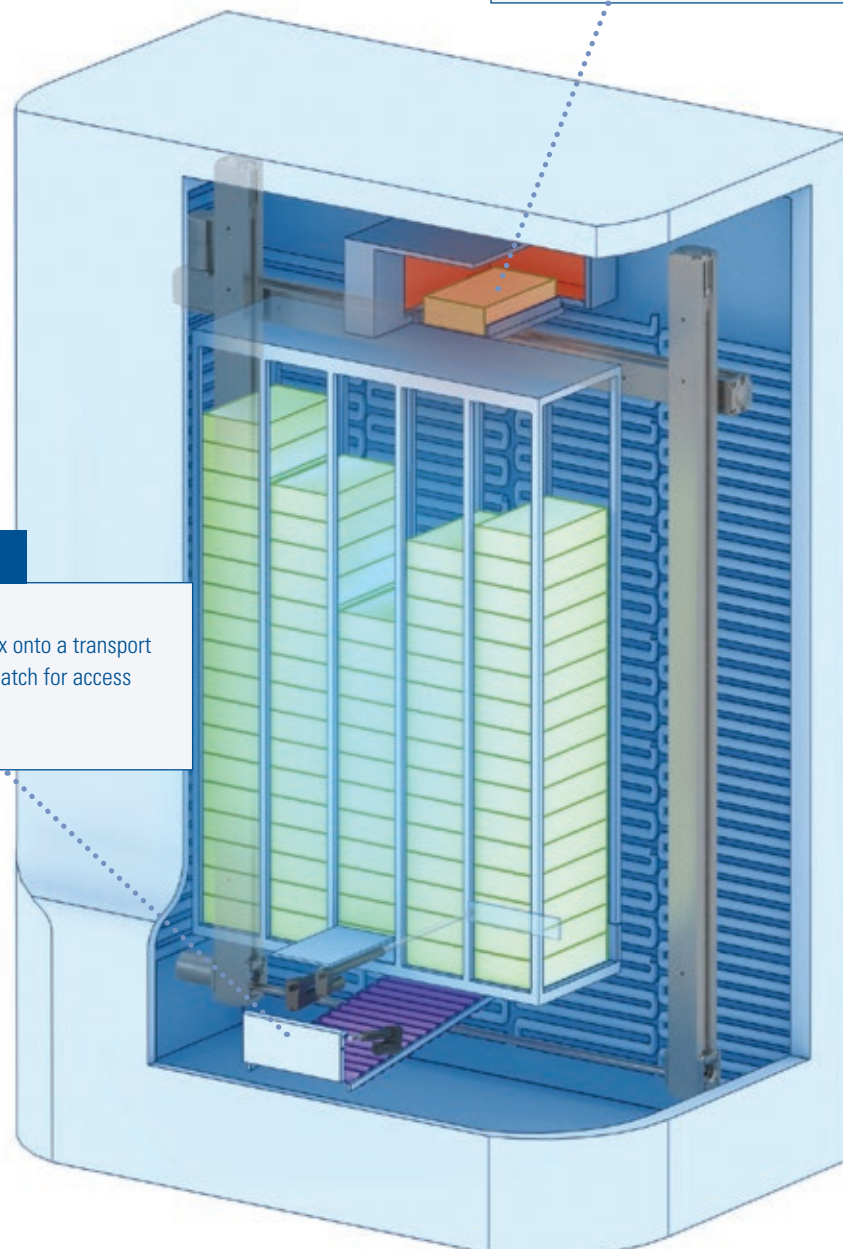



## Food Press

Food press applications can employ numerous Thomson components and fully engineered solutions. The press mechanism can make use of a high-load, rodded actuator with a friction break and feedback element. The stop block can be raised and lowered with the help of a linear actuator, and the slicer can employ a planetary gearbox and round rail linear guides – all resistant to corrosion and caustic cleaning elements. Underneath, a wrap-spring clutch helps index the motor driving the conveyor belt.

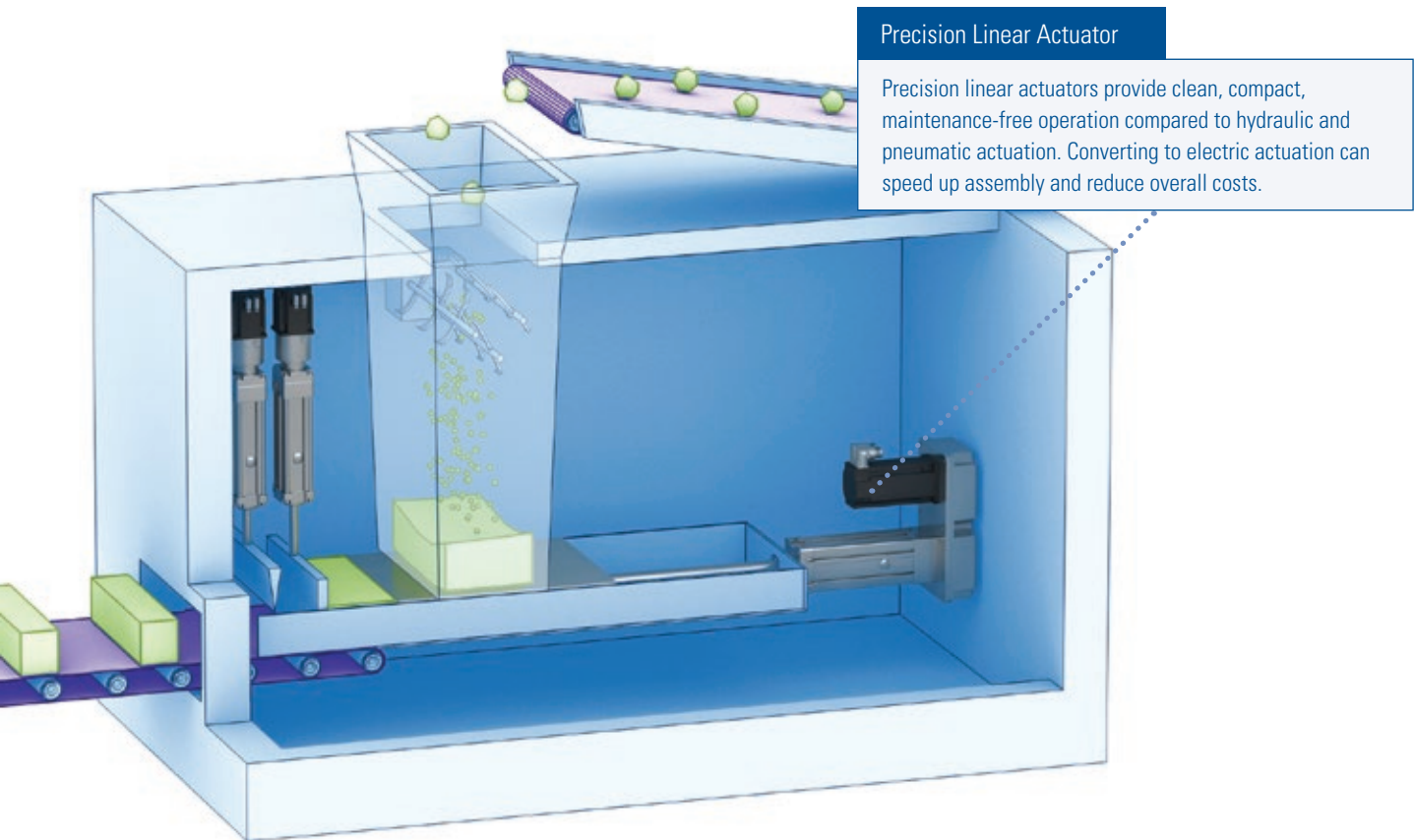

## Deboner

These heavy-duty positioning machines promote safety by handling the hard work of positioning carcasses for deboning. In this application, round rail linear guides are employed in an elevator that brings product to an overhead monorail crane system. Horizontal motion is driven by a zero-setup linear motion assembly with a stainless steel Micron gearhead. These components must be extremely durable and withstand high-pressure, caustic washdowns to ensure food safety.

### Crane System

The monorail crane system is modular, lightweight, and simple and fast to install.

### Linear System

As an alternative to pre-assembled systems, Thomson offers the widest available family of linear guides and components to construct custom linear systems.

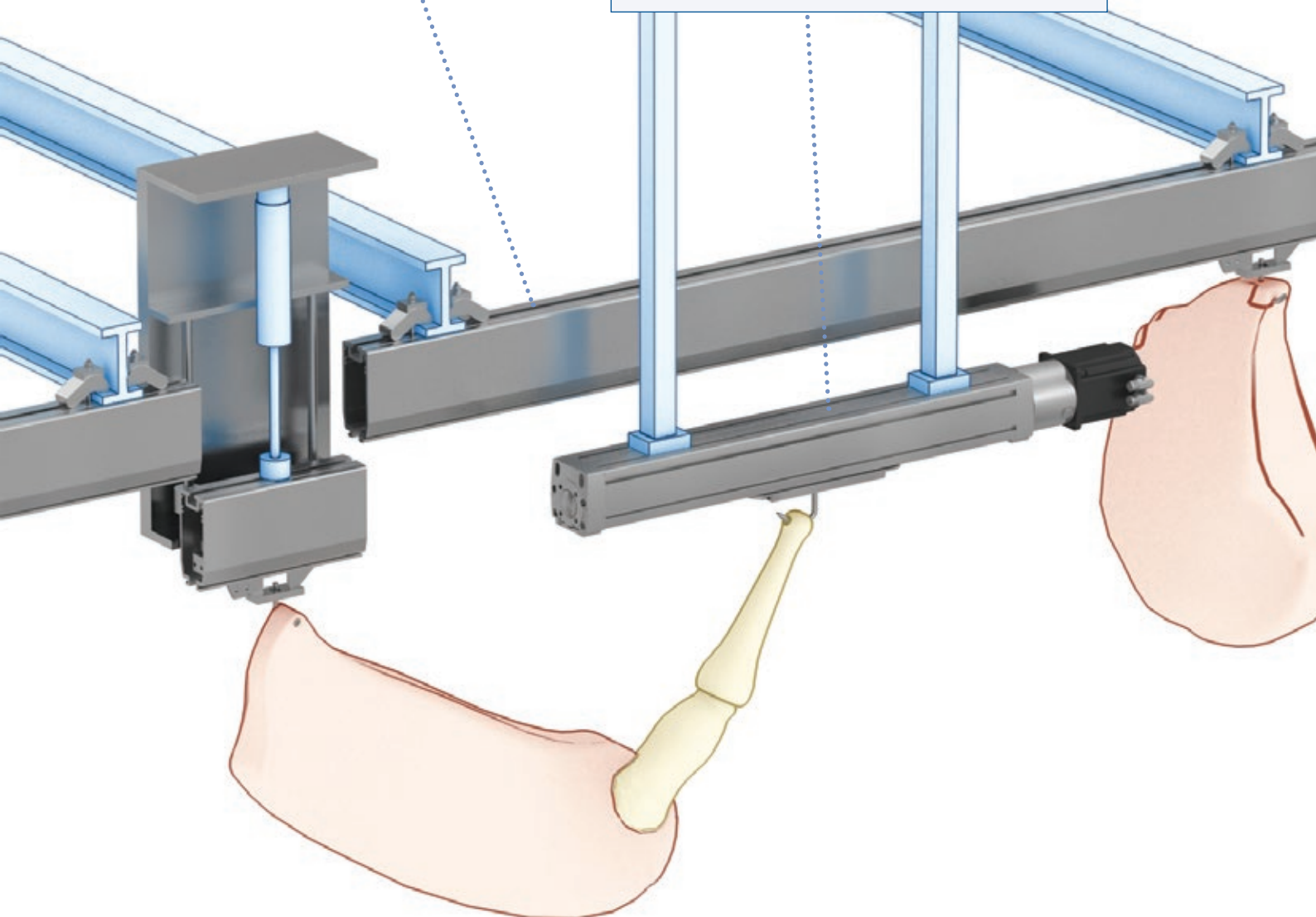



# Employ Superior Thomson Components

Leading-edge food-processing technology is built on leading-edge motion components, starting with minute engineering details we've mastered over decades of intense work. From patented anti-backlash technology for lead nuts to proprietary processing for roll-forming, our components are built to over-deliver.



## OPTIONAL

- Stainless Steel Protection
- Wash-Down or/and Chemical Protection
- Customization

### PROFILE RAIL

With sizes ranging from our ultra compact 5 mm MicroGuide™ to the robust 65 mm 500 Series roller, as well as compliancy ranging from our self-aligning T-Series (transport profile rail) to the extremely rigid, machine-tool-grade roller profile rail, Thomson is your one-stop source for all profile rail.

- 
- 
- 

### ROUNDRAIL LINEAR GUIDES & COMPONENTS

While shafts may appear the same, there are significant performance differences due to the manufacturer's selected standards and the manufacturing processes used to achieve them. Combine Thomson's unique design advantages with our tremendous on-hand stock, and you will have the tools to deliver the difference.

- 
- 
- 

### LEAD, BALL & GLIDE SCREWS

Thomson lead screws are the "just right" solution for many applications, and the patented zero-backlash nut technology provides excellent repeatability with high stiffness and extremely low drag torque.

For more demanding applications, we offer the most complete line of industrial ball screws in the industry. Our broad product offering and years of application expertise allow us to provide the right solution to meet your unique application requirements.

Part linear bearing, part lead screw, the unique Glide Screw™ combines the best features of these products into an easy-to-install, one-part solution. In addition, the Glide Screw eliminates alignment issues and comes standard with Thomson's patented Lube-for-Life technology for zero maintenance.

- 
- 
- 

### LINEAR ACTUATORS & MOTORIZED LEAD SCREWS

Our linear actuators are designed for rugged, reliable linear motion applications. Numerous choices in stroke, load, motor type, feedback, limits and control options make them very versatile. If you can't find the actuator to meet your application needs, call us for an actuator built to your specifications. We build more custom actuators than anyone in the world.

Our motorized lead screws combine a hybrid stepper motor and a precision lead screw in one compact envelope. Patent-pending Taper-Lock technology allows quick decoupling and secure, properly aligned connections. The result is a smaller, simpler and more precise overall design.

## Leverage Our Ability To Modify or Customize

Our application expertise is deep, and our product portfolio is very broad. The result: we can modify our standard products to any degree in a short timeframe. Similarly, we have the design and engineering expertise and technical knowledge to quickly deliver white sheet solutions for virtually any need. From standard products to modified standard to custom products, we can deliver what you conceive.

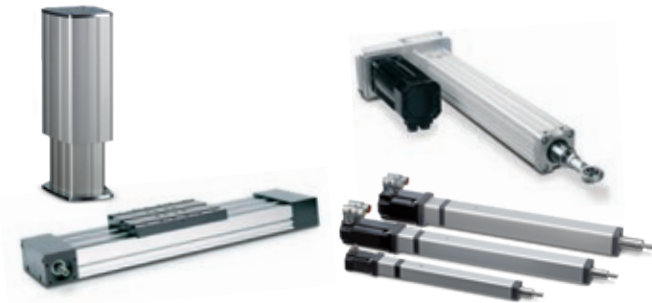

- Stainless Steel Protection
- Wash-Down or/and Chemical Protection
- Customization

## LINEAR MOTION SYSTEMS & LIFTING COLUMNS

Our linear motion systems can be used virtually anywhere. They can support and move a range of loads and provide high precision and tight tolerances. Pre-engineered, pre-assembled, ready to install, our systems support loads with ball guides, slide guides or wheel guides and actuation with either ball screw, lead screw or belt drive. Easy to use sizing and selection tools as well as 3D models are available at [www.linearmotioneering.com](http://www.linearmotioneering.com).

Thomson lifting columns provide modern design, high performance, and safe operation. Along with maintenance free life, easy installation, and light weight, these lifting columns are a first choice for domestic, medical, and work place applications.

## PRECISION LINEAR ACTUATORS

The compact design and the high load, accuracy and speed capacities of our precision linear actuators make them ideal for flexible integration in tight areas. These high-performance actuators come in several models and sizes with a broad range of options and accessories to meet the requirements of your application.

The EC and ECT Series are designed for heavier loads and are perfect for hydraulic replacement in the toughest environments.

The smaller PC Series is designed for drop-in replacement of pneumatic cylinders making, the shift to electrical actuation and control easy and fast.

Contact us or any of our 2000+ global distribution partners by scanning the code below  
or visiting [www.thomsonlinear.com/contact](http://www.thomsonlinear.com/contact)



**RegalRexnord™**

[www.regalrexnord.com](http://www.regalrexnord.com)

[www.thomsonlinear.com](http://www.thomsonlinear.com)

Food\_Processing\_Motion\_CPUK-0020-02 | 20260327KB | MCB-12426-TL-EN-A4  
Specifications are subject to change without notice. It is the responsibility of the product user to determine the suitability of this product for a specific application. All trademarks property of their respective owners. ©2026 Thomson Industries, Inc. | 2400 Curtiss Street, Downers Grove, IL 60515 USA

**THOMSON®**